

870/4 Adapter, 3/8" x 50 mm

Adapters en verloopstukken



GTIN:	4013288017079	Afmetingen:	50x13x13 mm
Onderdeelnr.:	05050215001	Gewicht:	26 g
Artikelnummer:	870/4	Land van herkomst:	CZ
		Goederencode (HS-code):	84661038

- Gereedschapshouder voor machinebediende steeksleutelinzetstukken
- Met 1/4" buitenvierkant-aandrijving
- 1/4" buitenzeskant-aandrijving (Wera aansluiting serie 4)

Gereedschapsschacht (verbindingselement) voor machine-aangedreven steeksleutelinzetstukken met buitenvierkant-aandrijving van Wera. Aandrijving 1/4" zeskant.

Weblink

https://products.wera.de/nl/bits_holders_adaptors_and_sets_holders_adaptors_connectors_adaptors_870_4.html

Wera - 870/4
05050215001 - 4013288017079



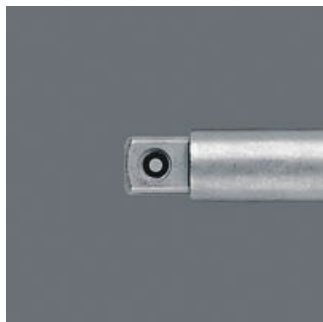

Wera Werkzeuge GmbH
Korzter Straße 21-25
D-42349 Wuppertal
Tel: +49 (0)2 02 / 40 45-0
E-Mail: info@wera.de

Met stift



Met stift; voor machinebediende doppen

Andere varianten in deze productreeks:

				
	inch	mm	inch	inch
05050205001 ¹⁾	1/4"	50	2"	1/4"
05050210001 ¹⁾	1/4"	100	4"	1/4"
05050215001¹⁾	3/8"	50	2"	1/4"
05050220001 ¹⁾	3/8"	100	4"	1/4"

1) Met stift; voor machinebediende doppen

Weblink

https://products.wera.de/nl/bits_holders_adaptors_and_sets_holders_adaptors_connectors_adaptors_870_4.html

Wera - 870/4

05050215001 - 4013288017079

Wera Werkzeuge GmbH

Korzter Straße 21-25

D-42349 Wuppertal

Tel: +49 (0)2 02 / 40 45-0

E-Mail: info@wera.de